

**Door Part**

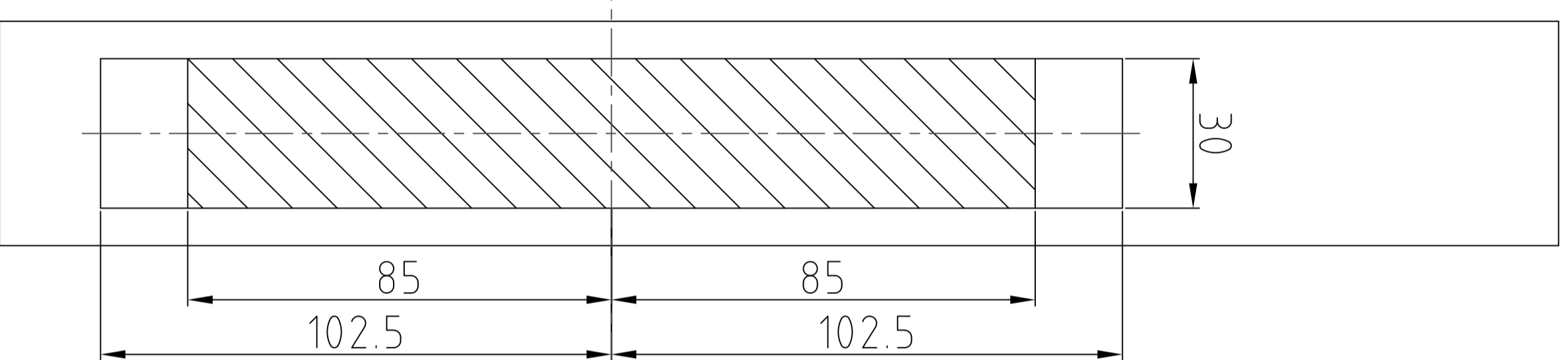

**Strike**

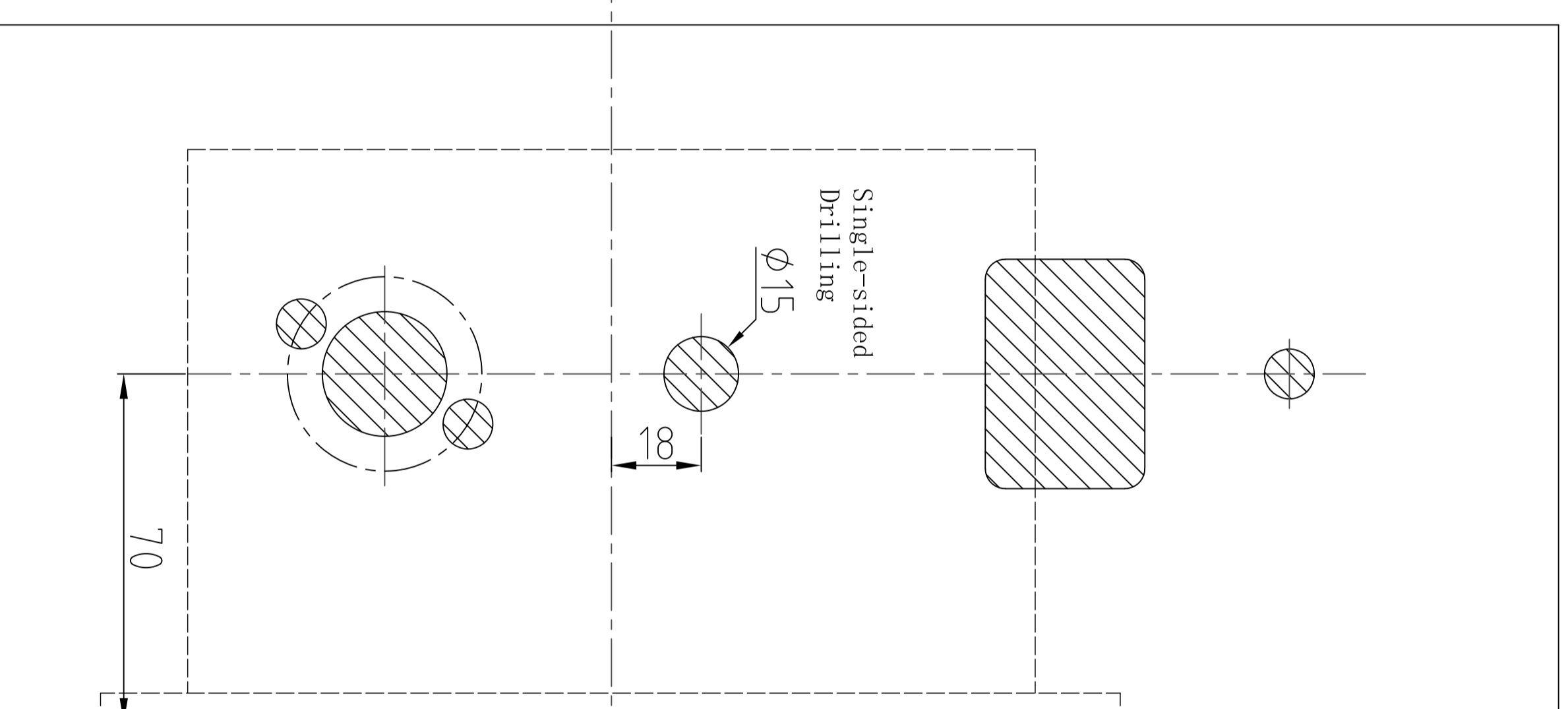

**Door Part**

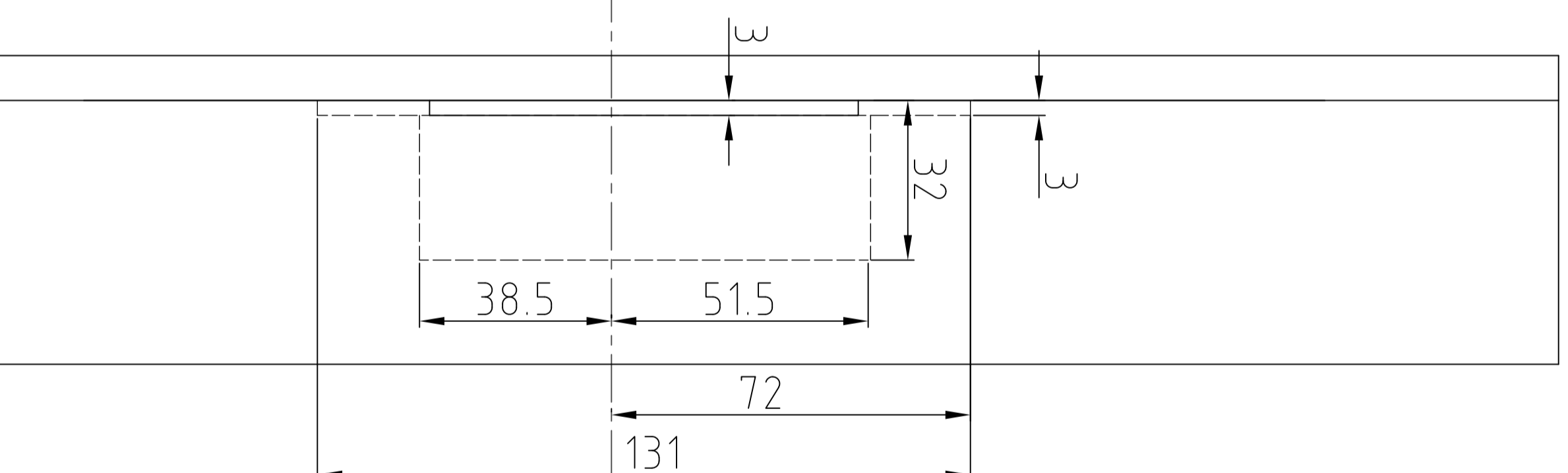

**Door Frame**

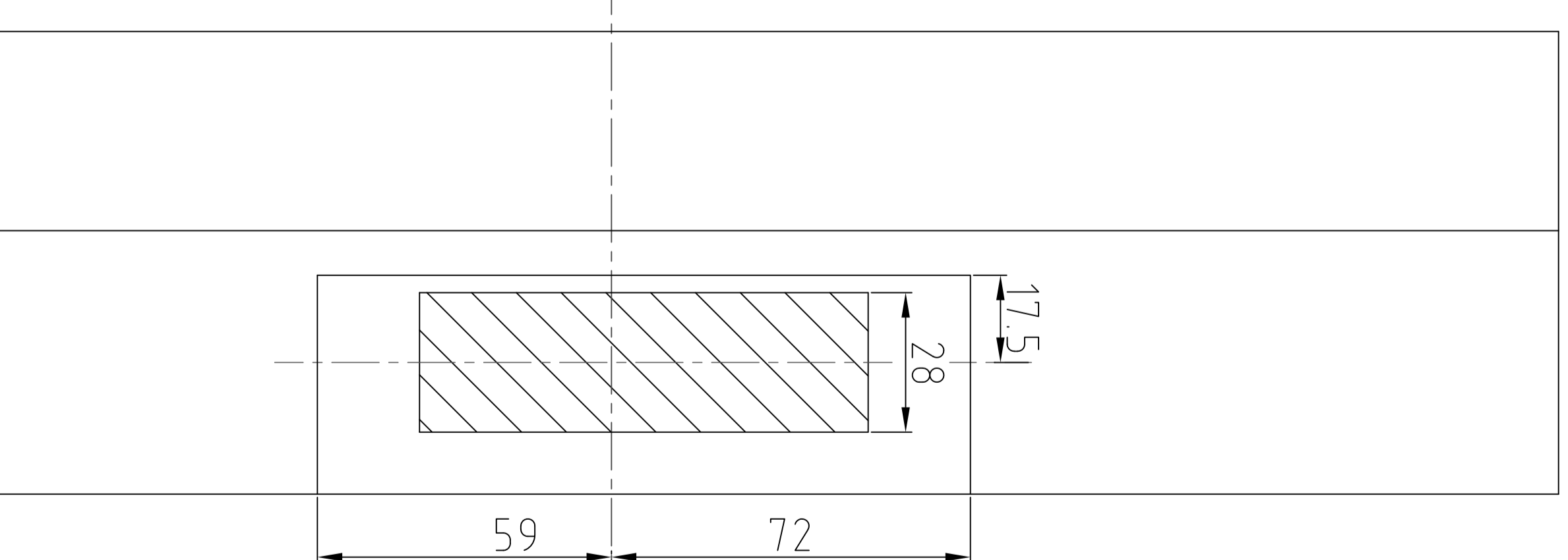

**Door Frame**

**Dimension Datum Line**

- Note:**
1. The continuous thick line parts are to be drilled, pls refer to the picture dimensions.
  2. Centerline of lock body is the dimension datum line.
  3. Dimension unit: mm.
  4. The carmine dot line part is lock body, the continuous thin line part is door part.

Hole Drilling Sketch			Models: S3078 Drilling-Right
Drawer	Yoru	2019-6-11	Models: M01D Mortise with Square strike plate
Assessor			Orbita Technology Co.,LTD